

DESIGN AND SIMULATION OF A FUZZY LOGIC TRAFFIC SIGNAL CONTROLLER FOR A SIGNALIZED INTERSECTION

C. M. Mwangi, S. M. Kang'ethe and G. N. Nyakoe

Department of Electrical and Electronic Engineering, Jomo Kenyatta University of Agriculture and Technology, Nairobi, Kenya

E-mail: maina.charles@gmail.com

Abstract

Traffic control and management poses a major problem in many cities, especially in rapidly growing and motorizing cities like Nairobi, Kenya. Currently, fixed-cycle controllers are being used in all signalized intersections in Nairobi. This has culminated in most intersections within the city almost grinding to a halt during peak hours. The efficiency of traffic flow through an intersection depends on the phases, sequence and the timing of the traffic signals installed. This paper proposes a fuzzy logic system to control traffic signals on a signalized intersection. The Fuzzy Logic Controller (FLC) dynamically controls the traffic light timings and phase sequence to ensure smooth flow of traffic, decrease traffic delays and thus increase the intersection capacity. In the design, vehicle detectors are placed strategically upstream and downstream to determine traffic density and the delay on each approach. This traffic data is then used by the FLC to determine whether to extend or to terminate the current green phase and to select the appropriate phase sequence. A fuzzy logic traffic control simulation model is developed and tested using MATLAB/ SIMULINK software. The performance of the Fuzzy Logic traffic controller is then compared to that of the fixed-cycle controller. The performance of FLC is found to be similar to that of the fixed controller in normal traffic conditions. However, in heavy traffic conditions, FLC results shows 25% decrease on average delay of cars waiting at the intersection and 6% improvement on total number of cars served at the intersection over the same simulation period compared to the fixed cycle controller. The results show that there is a huge improvement that can be realized by using FLC in controlling traffic flow at intersections.

Key words: Traffic control, Traffic flow, Signalized intersection and Fuzzy logic controller

1.0 Introduction

Optimization of the functioning of traffic signal is considered one of the most effective measures to address traffic congestion. However, the optimization of signal timing is complex due to randomness, complexity and nonlinearity of the transportation system. Fuzzy logic is suitable for controlling intersections, especially those with heavy traffic, because it is able to emulate the control logic of traffic police officers who sometimes replace traffic signal control when the intersection is congested [1].

The earliest known attempt to apply fuzzy logic in traffic control was made by Pappis and Mamdani [2]. They implemented a fuzzy logic controller in a single intersection of two one-way streets. Ever since, much similar research has been done and generally reported better performance of the fuzzy logic controllers compared to the pre-timed controllers [3-9]. This paper presents a fuzzy traffic signal control system which seeks to improve the intersectional capacity of signalized intersections by increasing the vehicle throughput while reducing their delay at the intersection.

This paper is organized as follows. In section II, description of fuzzy logic traffic signal control system for a signalized intersection is presented. To evaluate the performance of the controller, the simulation of the fuzzy logic traffic signal control model is carried out in section III. The results of the simulation FLC system is compare to the fixed-time controller and discussions of these results are presented in section IV. The conclusions of the paper are given in the last section.

2.0 Materials and Methods

2.1 Design of Traffic Control System

The general structure of the fuzzy traffic lights control system model will have the structure shown in figure1. The fuzzy traffic light control system will utilize two sets of inductive loop sensors on each approach to the intersection; one just before the intersection and the other a predetermined distance from the intersection to gather traffic data information.

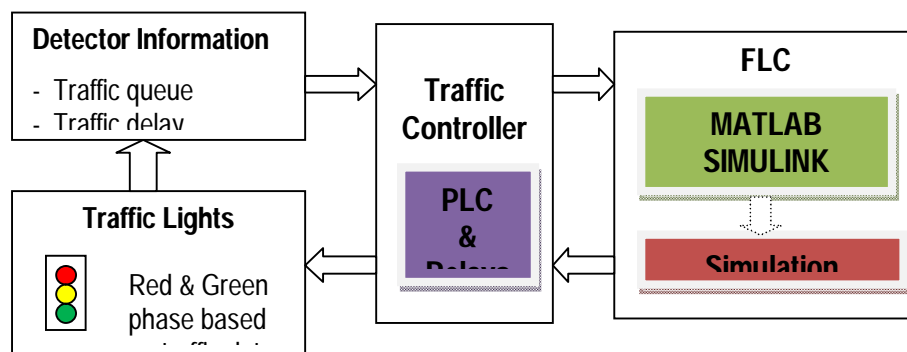

Figure 1: A general structure of the fuzzy traffic lights control system model

This traffic data information will be used by the fuzzy logic controller to select the phase with highest priority and also to determine whether to extend the current green phase. The information on the selected phase and/or extension time from the FLC will be inputted to the PLC for actuation. The sensors and traffic lights are connected to the Programmable Logic Controller (PLC) via the relay interface and protective devices.

2.1.1 Intersection Structure

The structure of intersection is based on Lang'ata/Mbagathi signalized roundabout which has four approaches as

illustrated on figure 2. The roundabout has four approaches: Lang'ata road (from Nairobi), Mbagathi road, Lang'ata road (from Wilson airport) and Mai Mahiu road. Inductive loops for vehicle detection are installed on the stop lines and 100m upstream on each approach to collect traffic data. The amount of vehicles in each approach will be determined by the difference of the readings between the two sensors.

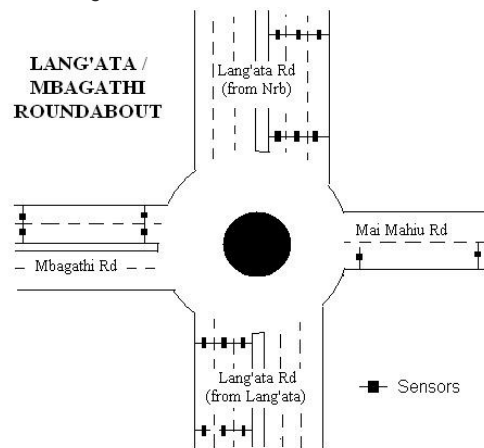

Figure 2: Overview of Lang'ata/Mbagathi Roundabout

2.1.2 Input and Output Parameters

The fuzzy logic system will use information from the inductive loop sensors to determine the number of cars between the two set of the sensors. This will provide the controller with traffic densities in the lanes and allow a better assessment of changing traffic patterns. The input and output parameters for the fuzzy logic traffic signal controller for this paper are as follows:

Input parameters of the phase selection and green phase extension model

- Queue Length in Red Signal [QR] (short, medium, long)
- Waiting Time of Longest Queue in Red Signal [WR] (short, medium, long)

Output parameters of the phase selection and green phase extension model

- Next phase with highest priority [W(p)] (Fuzzy)
- Green phase extension or termination [Ext] (Embedded MATLAB)
- Selection of the next phase based on Weight [P] (Embedded MATLAB)

2.2 Simulation of Fuzzy Logic Traffic Controller

In this paper, MATLAB and SIMULINK programming environment is used to develop the simulation model. The simulation model is developed using Simulink, Fuzzy Logic and SimEvents toolboxes as well as MATLAB workspace environment.

The fuzzy logic controller determines phase sequence and whether to extend or terminate the current green phase based on a set of fuzzy rules. The fuzzy rules computes the phase with the highest degree of priority based on queue length and waiting time and then uses this traffic data to select the phase and determine the duration of green phase extension, if any.

2.2.1 General Structure of the Simulation Model

The selection of the phase with the highest priority is achieved by using SIMULINK sub-system blocks representing each approach as shown in figure 3. The priority level of each approach is generated using the FLC block. The

outputs the approaches sub-systems are combined into the traffic signal intersection block that comprises of the FLC control unit and the input switch block. The input switch block selects the approach to be granted the green phase based on the FLC control unit.

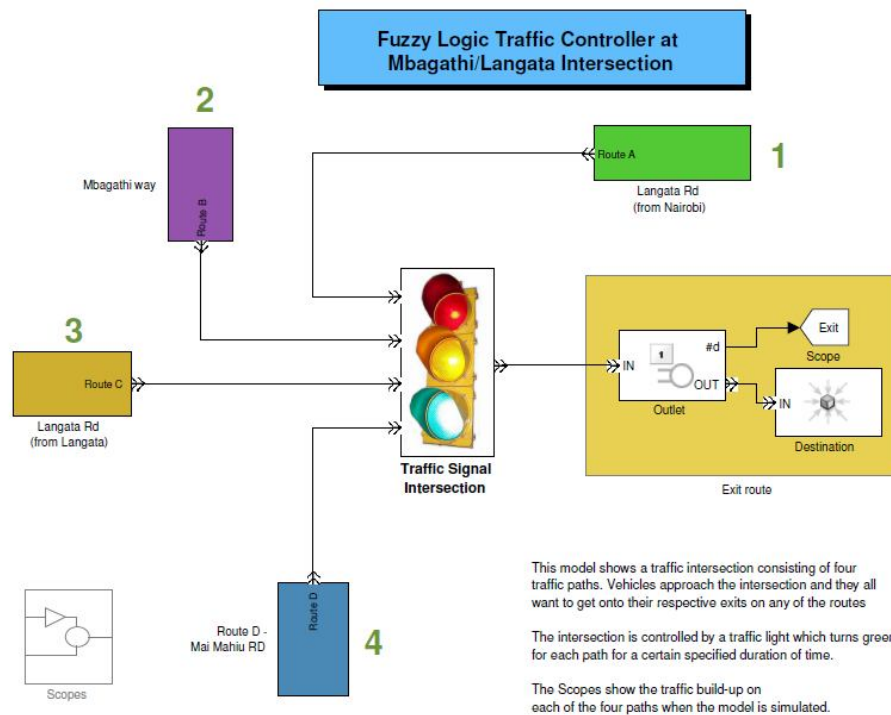

Figure 3: General structure of the FLC Traffic control model

2.2.2 Weight or Priority of Phase

The priority or weight of an approach is derived from determining the delay and the number of queuing vehicles in each of the approaches. It is assumed that initially the approach "A" is given right of way i.e. green signal is given to the vehicles on approach "A". Figure 4 shows the internal structure of each of the intersection approach sub-system.

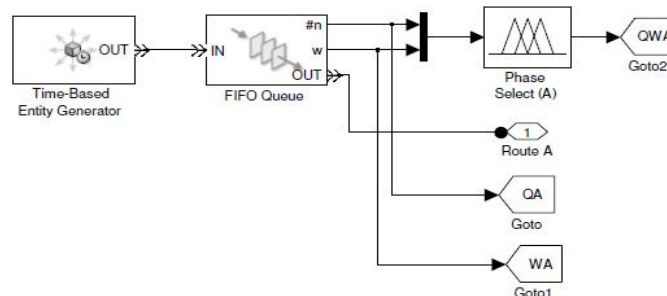

Figure 4: FLC subsystem model of each approach

The input and output parameters used on the FLC block to determine the level of priority of each approach are:

Input Parameters:

QR - Queue length in Red phase (Short, Medium, Long)

WR – Waiting time in longest queue in Red (Very Short, Short, Medium, Long)

Output Parameter:

W(p) – weight or level of priority of phase

The membership functions (MFs) of the fuzzy sets of the input and output parameters for the next phase and Green phase extensions are represented using Gaussian MFs. The fuzzy rules for determining the approach with the highest degree of priority or weight are illustrated in Table1. The fuzzy rules are identical for all the four approaches.

Table 1: Fuzzy rules of Weight of Red Phase

No	FUZZY RULES
1.	IF {QR is Short} AND {WR is Short} THEN {W(p) is Low}
2.	IF {QR is Short} AND {WR is Medium} THEN {W(p) is Low}
3.	IF {QR is Short} AND {WR is Long} THEN {W(p) is Medium}
4.	IF {QR is Medium} AND {WR is Short} THEN {W(p) is Low}
5.	IF {QR is Medium} AND {WR is Medium} THEN {W(p) is Medium}
6.	IF {QR is Medium} AND {WR is Long} THEN {W(p) is High}
7.	IF {QR is Long} AND {WR is Short} THEN {W(p) is Medium}
8.	IF {QR is Long} AND {WR is Medium} THEN {W(p) is High}
9.	IF {QR is Long} AND {WR is Long} THEN {W(p) is High}

2.2.3 Next Phase Selector

Determining the next green phase is based on a set of If-Then Embedded MATLAB code rules, some of which are illustrated in Table2. The If-Then rules determine the current phase and use the traffic data depicting the weight of the other phases from the fuzzy logic unit to determine the next phase. The candidate red phase approach with highest priority degree is selected. The default green phase of the system is approach A.

Table 2: Part of Embedded MATLAB rules of the Green Phase Selector

```

&& Phase Selection
function y = fcn(a, b, c, d, p)
%% Phase A
    if ((p==1) && (b<=4) && (c<=4) && (d<=4))
        y = 2;
    elseif ((p==1) && (b<=4) && (c<=4) && (d>4))
        y = 4;
    elseif ((p==1) && (b<=4) && (c>4) && (d<=4))
        y = 3;

```

2.2.4 Green Phase Extension

Determining whether to extend or terminate the current green phase is based on a set of If-Then Embedded MATLAB code rules. The If-Then rules compares the traffic condition with current green phase and traffic condition

with the other candidate green phase (the red phase with the highest priority degree). Each phase has a minimum green time (T_{min}) of 20sec and a maximum green time (T_{max}) of 30sec. Some If-Then rules for the Green Phase extension are illustrated in Table3.

Table 3: Embedded MATLAB rules of the Green Phase Extender

```

    && Phase Extension
    function ext = fcn(a, b, c, d, p)
    %% Phase A
    if ((p==1) && (b<=4) && (c<=4) && (d<=4))
        ext = 0;
    elseif ((p==1) && (b<=4) && (c<=4) && (d>4))
        ext = 5;
    elseif ((p==1) && (b<=4) && (c>4) && (d<=4))
        ext = 5;
    elseif ((p==1) && (b<=4) && (c>4) && (d>4))
        ext = 10;
    end
  
```

2.2.5 Fuzzy Logic Control Unit

The fuzzy logic control unit (figure 5) forms the brains that control the selection and extension of the green phase. Inputs depicting the weight or level of priority on each approach are inputted to the phase extension sub-system which determines whether to extend or terminate the green phase. The value from the phase selection sub-system is added to the T_{min} (20sec) to get the duration of the green time extension, T_{Ext} , which is used as an attribute for determining the server duration. Every time an entity is served by the server, a function call is generated which activates the phase selected by the phase selector subsystem.

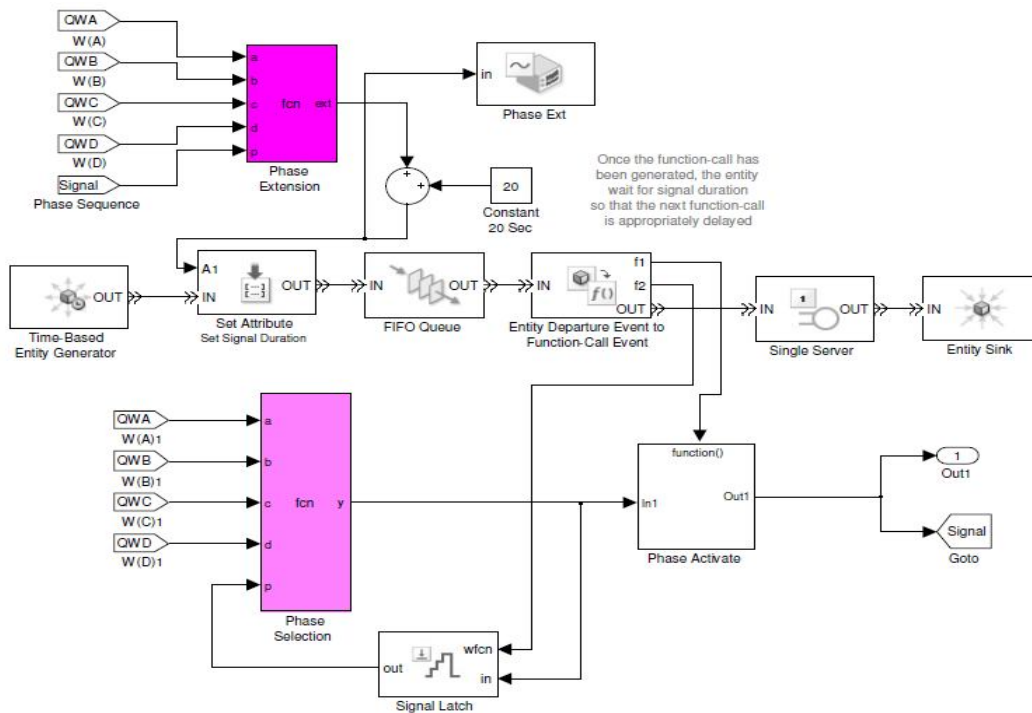

Figure 5: FLC control unit of Simulation model

3.0 Results and Analysis

The simulation for the fuzzy logic traffic signal controller is carried out using MATLAB, SIMULINK and the Fuzzy Logic Toolbox. The developed Fuzzy logic model is compared with fixed-time controller. The simulator is run for 1000 seconds with the following conditions:

- (i) The arrival of vehicles on each approach is A(3), B(5), C(2) & D(6).
- (ii) The green time (in sec) of each phase is determined by the server
 - Fixed-time controller: A(30), B(30), C(30) & D(20)
 - FLC: min (20) and max (30)

3.1 Results

The results of the simulation of the vehicles on each approach using fuzzy and fixed-time controllers are illustrated in figure 6. It can be seen that the length of queues in fixed-time controller are longer than those of the fuzzy controller. Figure 7 shows the average vehicle delay at the intersection. It can be seen that vehicles spend more time in an intersection using fixed-time controller than the one using Fuzzy controller.

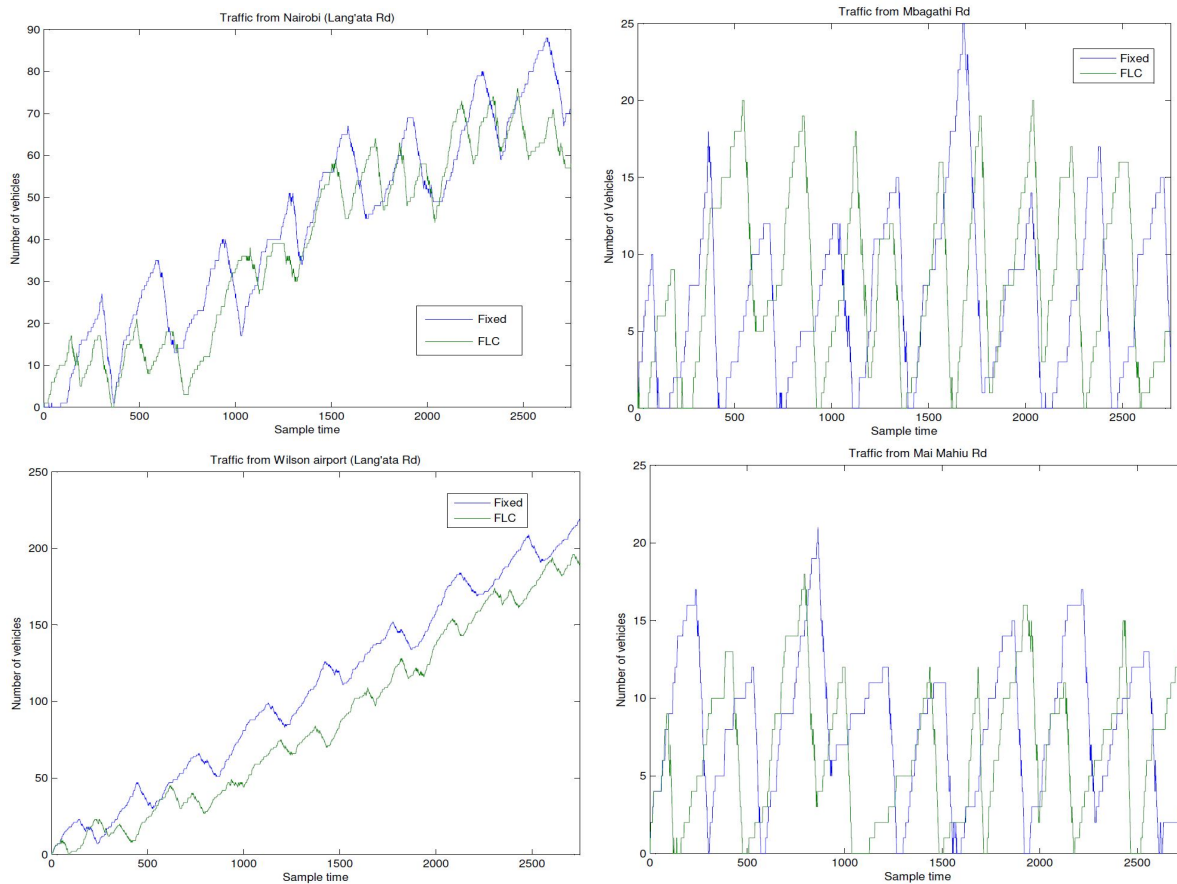

Figure 6: Traffic queues on each approach of the intersection

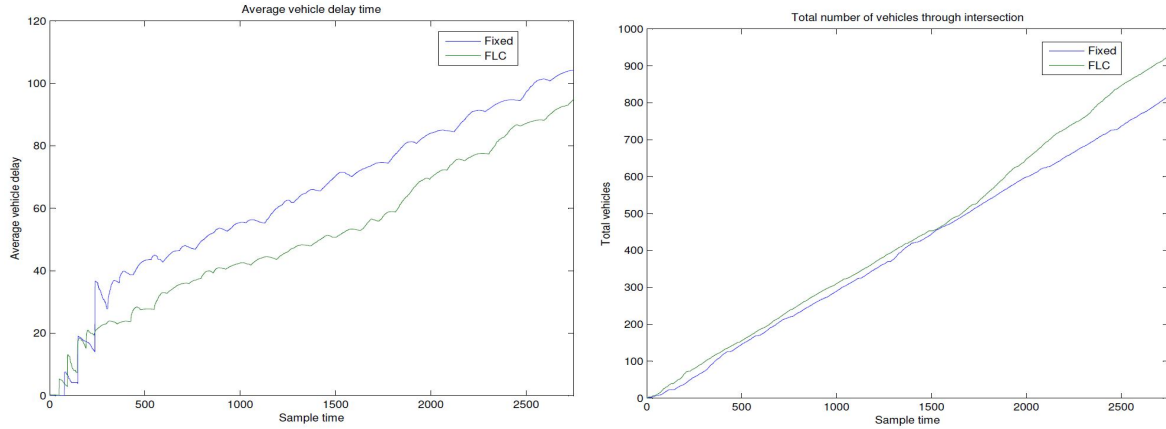

Figure 7: Traffic queues on each approach of the intersection

Figure 8 shows the phase sequences of the fixed-time controller and fuzzy controller. It can be seen that the sequence of fixed-time controller follows the sequence of 1-2-3-4 representing the four approaches. The phase sequence of the fuzzy controller is dictated upon by the weight of each phase with the one with highest priority granted green phase. Figure 9 shows the extension duration granted again based on the weight of the green phase.

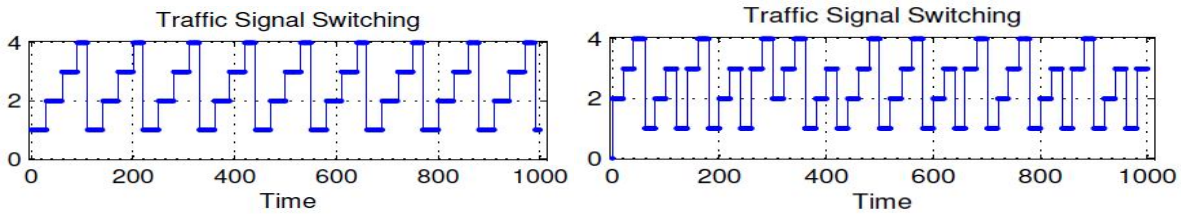

Figure 8: Phase sequence of the controllers at the intersection

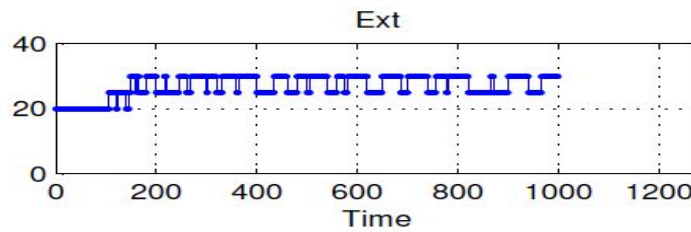

Figure 9: Phase extension duration of the Fuzzy Controller at the intersection

3.2 Analysis

The performance comparison between fixed time controller and fuzzy traffic controller is summarized in Table 4. As can be seen, the fuzzy logic controller shows about 25% decrease in time on average vehicle delay at the intersection and about 6% increase on the total number of cars being served at the intersection.

The graphs on figure 6-9 clearly show that as traffic volume increases the fixed-time controllers perform much poorer than the fuzzy controller. The fuzzy controller is able to increase the green time to cater for the increasing traffic. When handling low volumes of traffic, both controllers perform more or less the same with the fixed controller. However, as the traffic volumes increase considerably, the performance of the fixed-time controller reduces compared to that of the fuzzy logic controller.

Table 4: Simulation results for Fixed-time and Fuzzy Logic Controller

Simulation parameters	Fixed Controller	Fuzzy Logic
Simulated time (in sec)	1000	1000
Number of cars served	878	934
Average delay (in sec)	118	92

4.0 Conclusion

In this paper, the traffic model and traffic controller are developed using MATLAB software. To test the effectiveness of fuzzy controller to control the traffic flow at an isolated intersection, the MATLAB simulation has been done. The comparison of the proposed controller with the fixed-time controller has shown overall, the fuzzy logic controller shows good performance for controlling traffic flow.

As can be seen, the performance of fuzzy traffic controller is better than fixed-time controller in terms of average number of cars waiting, total departure, and average delay. Each of these features give a positive improvement which indicates that fuzzy logic controllers are better suited in controlling traffic than fixed-time controllers. The fuzzy logic controller model can be modified to suit any intersection by varying the input membership functions which further increases the suitability of this traffic control system.

References

- Zhang, L., Honglong, L. and Panos, D. (2004). Signal Control for Oversaturated Intersections using Fuzzy Logic, submitted for consideration for presentation at the 2005 Annual meeting of TRB, Honolulu, Hawaii.
- Pappis, C. P, and Mamdani, E. H. (1977). A Fuzzy Logic Controller for a Traffic Junction, IEEE Transactions on Systems, Man, and Cybernetics, Vol. SMC-7, No. 10, October 1977, pp. 707-717.
- Chiu, S. I.(1992). Fuzzy Logic Traffic Signal Control System, United States Patent, Patent Number 5,357,436, Thousand Oaks, Calif.
- Niittymäki, J. and Pursula, M. (2000). Signal Control using Fuzzy Logic, *Fuzzy Sets and Systems*, Vol. **116**, pp. 11-22.
- Niittymäki, J. and Kikuchi, S. (1998). *Application of Fuzzy Logic to the Control of a Pedestrian Crossing Signal*, Transportation Research Record: Journal of the Transportation Research Board No.1651, TRB, National Research Council, Washington, D.C., pp. 30-38.
- Niittymäki, J. and Mäenpää M. (2001). The role of Fuzzy Logic Public Transport Priority in Traffic Signal Control, Department of Transportation Engineering Helsinki University of Technology, Finland.
- Nair, B. M. and Cai, J. (2007). A Fuzzy Logic Controller for Isolated Intersection with Traffic Abnormality, Proceedings of the 2007 IEEE Intelligent Vehicles Symposium, Turkey, June 13-15, 2007.
- Farmy, M. M. (2007). An adaptive Traffic Signaling for Roundabout with Four-Approach Intersections based on Fuzzy Logic, *Journal of Computing and Information Technology – CIT* 15, 2007, 1, pp. 33-45.
- Niittymäki, J. (2001). Installation and Experiences of Field Testing a Fuzzy Signal Controller, *European Journal of Operation Research*, Vol **131**, pp 273-281.
- Sivanandam, S. N., Sumathi S. and S. N. Deepa S. N. (2007). Introduction to Fuzzy Logic Using MATLAB, Springer-Verlag Berlin Heidelberg, Tamil Nadu, India.
- Mathworks (2002). Fuzzy Logic Toolbox: User's Guide (V2.1), The Mathworks Inc.
- Mathworks (1999). Using SIMULINK: Version 3, The Mathworks Inc.
- Mathworks (2009), *SimEvents 3.0*, The Mathworks Inc.